



TruLaser Weld

A winning  
connection

# Earn more with laser welding

Welding is already part of your service portfolio. What if you could produce much faster on your new welding system and thus save costs? On the following pages we will show you how this is possible.



**Automated laser welding catapults your sheet metal operations into a new league.**

The LED strip lighting at Terminal 1 of Frankfurt Airport was developed by LMT Leuchten + Metall Technik GmbH in Hilpoltstein, Germany, laser-welded and completely built.

<b>Create opportunities</b> _____	<b>4–5</b>	<b>TruTops Weld: Faster programming, parallel production</b> _____	<b>24–25</b>
Exploit savings potential, identify growth potential		The navigation device for laser welding	
<b>Laser welding pays off</b> _____	<b>6–7</b>	<b>Boosting productivity with knowledge</b> _____	<b>26–27</b>
Unlimited possibilities		WeldGuide, seminars, etc.	
<b>The right method every time</b> _____	<b>8–9</b>	<b>Easy automation of manual welding</b> _____	<b>28–29</b>
An overview of laser welding		TruArc Weld 1000	
<b>It pays off!</b> _____	<b>10</b>	<b>Your Smart Factory</b> _____	<b>30–31</b>
Cost comparison		Digital networking gives you great freedom	
<b>User feedback</b> _____	<b>11</b>	<b>TruServices. Your partner in performance</b> _____	<b>32–33</b>
What our customers think		We've got you covered	
<b>TruLaser Weld 1000</b> _____	<b>12–15</b>	<b>Passion is what drives us</b> _____	<b>34–35</b>
Simply successful		Locking in competitive advantages	
<b>TruLaser Weld 5000</b> _____	<b>16–21</b>		
Productive and flexible			
<b>Technical data</b> _____	<b>22–23</b>		

# Create opportunities

Take advantage of this opportunity to greatly increase revenue by manufacturing your parts at a fraction of the cost with laser welding. It also brings new contracts your way because you can work faster and offer more than your competitors. The fact is that joining offers more potential to save money than any other machining step in the sheet metal process chain!

## Provide outstanding quality

### High-quality seams

Are your customers looking for extremely stable or visually appealing seams? If so, laser welding is a great choice. It produces high-strength, tight, and aesthetically pleasing weld seams.



### Minimal distortion

The simple solution for high-precision welding. Laser welding has a lower heat input than arc welding, resulting in less distortion in the welding zone. That makes downstream processing easier.

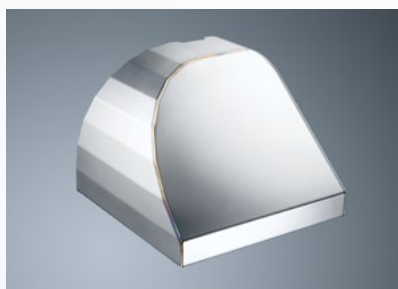

### Reproducible results

Automated laser welding offers consistent quality because robots remember every step perfectly.

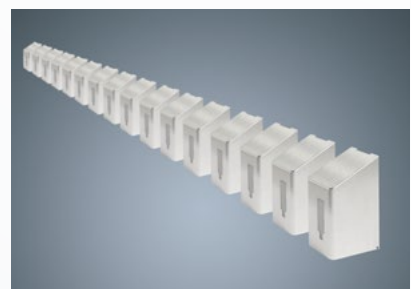

## Save time, cut costs

### Less finishing work

Lasers produce high-quality seams, often without requiring any finishing or grinding at all. Distortion is also kept to a minimum, eliminating the need for straightening. What's more, laser welding offers big savings on consumables such as grinding wheels.



Once you start using laser welding, you'll need far fewer grinding wheels.

### Huge time benefits

Laser welding is fast – and that makes it highly productive. It also involves fewer secondary operations, so you save an enormous amount of time.



See how much time you can save in this short video:  
[www.trumpf.info/eki40u](http://www.trumpf.info/eki40u)



The longer your current welding process takes and the more finishing work it involves, the faster an investment in laser welding will pay off.

## Embrace flexible production

### New seam geometries

Laser welding opens up a wide variety of new seam geometries, giving you more freedom when it comes to designing your parts.

Materials of different thicknesses

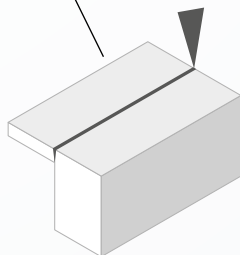

Lap seams

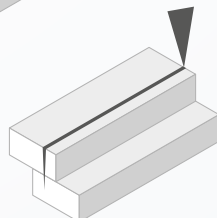

### Enhanced production capacity

A laser solution also helps you respond to big orders that come in unexpectedly – it handles series production orders faster and is immediately ready to process the next job.

Round geometries

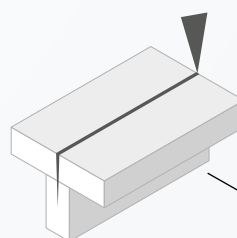
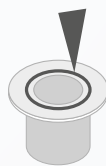

Concealed T-joints

# Laser welding pays off

Quality matters – and the benefits of laser welding are coming to the fore in many different industries. These include machine builders, kitchen and furniture makers, installation engineering, design engineering, and luminaire technology, as well as the food industry and electronics sector. Strong, deep, tight welds are crucial for applications such as water tanks. In contrast, counter segments require aesthetically pleasing visible weld seams with a smooth, rounded surface.

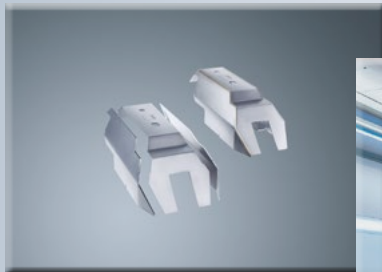

## Container and apparatus engineering

**Key requirements:**  
Tight welds



## Mechanical and plant engineering

**Key requirements:**  
Low tolerances, high strength

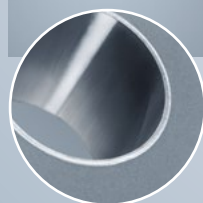
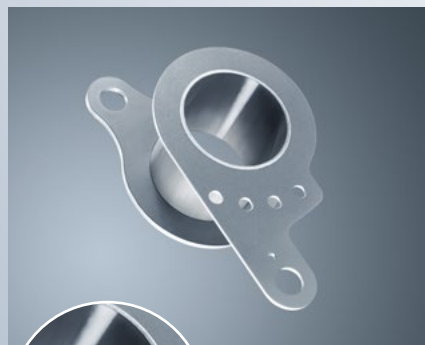

## Medical technology, furniture industry, sanitation

**Key requirements:**  
Minimal distortion, visually appealing

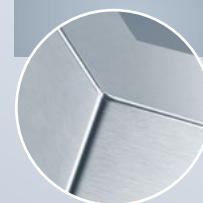



### Electrics and electronics

**Key requirements:**  
Minimal distortion, aesthetically pleasing

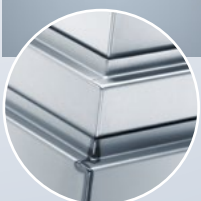

### Construction of machines and housings

**Key requirements:**  
Minimal distortion, aesthetically pleasing

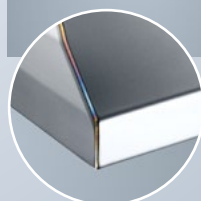
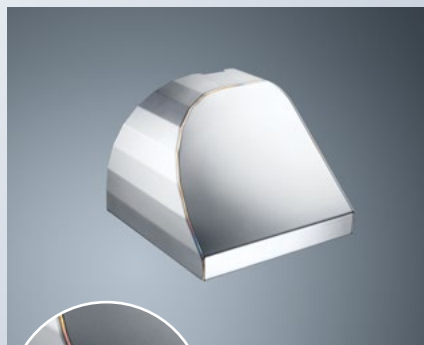

### Food technology, kitchen makers

**Key requirements:**  
Aesthetically pleasing, tight weld

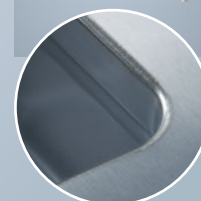

# The right method every time

Heat conduction welding, deep penetration welding or BrightLine Scan, or FusionLine: Depending on the component, you can flexibly select the appropriate welding process. This applies to all common materials, such as mild steel, stainless steel, or aluminum.

## Laser welding is tremendously versatile

### Heat conduction welding

Aesthetically pleasing welds and maximum surface quality: The laser melts the workpieces along the joint, providing the perfect connection for thin-walled pieces. Heat conduction welding produces visually appealing visible seams with low distortion. In many cases, the parts require no further work.

- Highest optical seam quality
- Radius without grinding



### Deep welding

Fast speed, high-tensile seams: The laser heats the raw material up to a temperature where the material doesn't just melt, but also vaporizes in part. The laser beam can penetrate deep into the material and also joins thick-walled parts together.

- Top productivity
- More design freedom

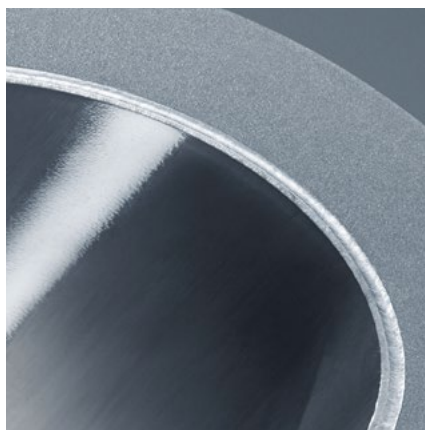

### FusionLine

On the TruLaser Weld 5000, you have the option of feeding supplementary wire into the welding process. This expands the range of applications, as components with larger gaps can also be welded with the laser.

- Bridging the largest gaps
- Joining with filler material

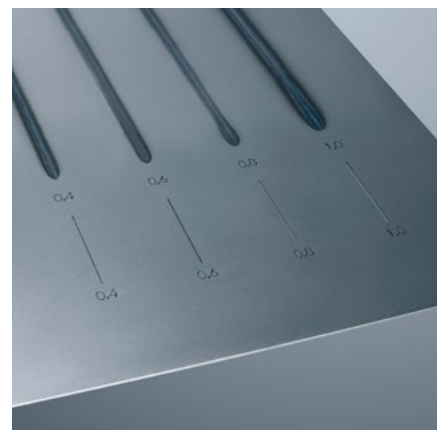



**Want to take it up a notch? With BrightLine Scan on the TruLaser Weld 5000, you can expand your range of applications.**

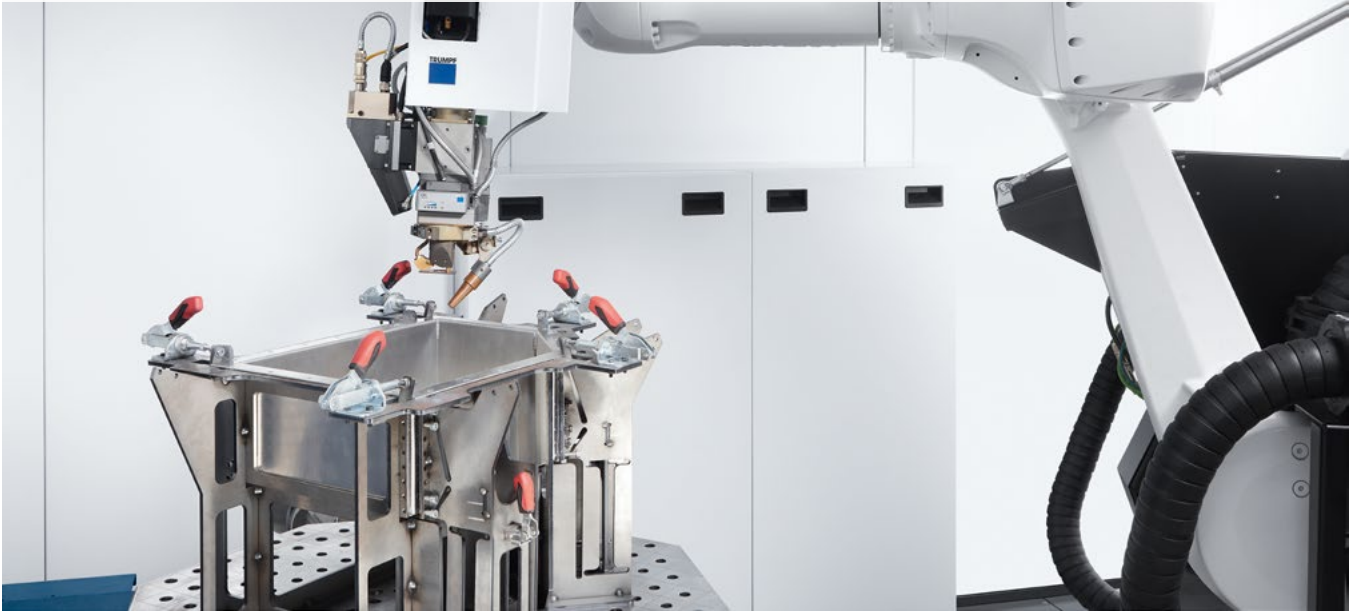

### BrightLine Scan

In this welding process with beam oscillation, two programmable mirrors move the laser beam. Frequencies of up to 2,700 Hz ensure an extremely robust and flexible welding process. The beam movement can be programmed in almost any way. This offers advantages and new fields of application for the laser.

- ⊕ Higher tolerance during welding
- ⊕ Brilliant quality for aluminum
- ⊕ Targeted adjustment of seam width
- ⊕ Thicker sheets during heat conduction welding
- ⊕ Corners  $\neq 90^\circ$  process-reliable welding



Difficult corners and gaps can be welded better without supplementary wire.

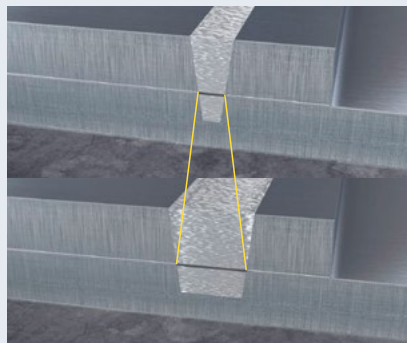

The seam width and the connection cross-section for overlap seams can be set flexibly.



The high frequencies produce impressive results in aluminum.

# It pays off!

The economic comparison with the example of an aluminum terminal box shows: with automated laser welding, you can reduce the time required by up to 85% and reduce costs per part by 53% in the case of joining.

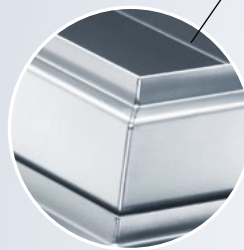

500 pieces per year (10 x lot size 50)  
aluminum, 1.5 mm  
60 cm weld seam

## MIG manual welding

## Laser welding

Hourly cost*	60 €	149 €
Fixture costs	0 €	1,500 €
Programming time	0 min	120 min
Set-up time per batch	7 min	10 min
Welding time per part	18 min	3 min
Handling time per part	2 min	1 min
Rework per part	10 min	0 min

<b>Total time*</b>	<b>251 h</b>	<b>37 h</b>	← About 85% savings
<b>Total cost*</b>	<b>15,070 €</b>	<b>7,013 €</b>	← 53% savings
<b>Cost per part*</b>	<b>30.14 €</b>	<b>14.03 €</b>	



Utilize 50% of your system's capacity with these kinds of parts in one shift, and it will pay off within approx. two years.

\*These figures are based on average figures typical for Germany.

# User feedback

"The only thing I regret is we didn't start using it sooner."

Werner Neumann, Managing Director  
CBV Blechverarbeitung GmbH



"Now we cut the parts\* with the laser and deep-weld them on the rear side. Due to the low heat input, we have no distortion. We brush over it again and save 95% of the previous costs."

\* Aluminum U profile previously milled from solid material.

"We used to need 2 hours to manually weld the very complex housing for TRUMPF, consisting of 40 single parts. Now the straight welding time is only 5 minutes."

Norbert Schmitz, Production Manager at apra-norm Elektromechanik GmbH

"Our customers have extremely high expectations in terms of quality for the very demanding food product market – and that can only be achieved with the laser."

Vaclav Kriz, Production Director at Sinop



"To produce a flour duster, we require around 110 minutes when using a manual welding process. With the TRUMPF welding cell, we only need around 10 minutes."

Stephan Schink, CEO of Schink Blechbearbeitung und Metallbau GmbH und Co. KG

"The option of motor-driven focusing was important to us. We can use this to quickly switch between a heat conduction seam with a low welding depth and a deep penetration weld."

Florian Friedrich, CEO at Autz + Herrmann



"We work with a KUKA robot on a linear axis and a turnover positioner. This allows us to cover a large work area of 4 m in length and 1.20 m in width."

Josef Böhmer, CEO of Böhmer Systemtechnik GmbH

# TruLaser Weld 1000



01

## Top quality

welding with the laser

02

## Productive

welding in two-station operation

### **Automated laser welding: Simply successful**

Lack of welding specialists, increasing quality pressure – the need for simple automation for time-consuming welding is enormous. This is why the compact TruLaser Weld 1000 combines particularly easy operation and programming with the advantages of laser welding. You weld faster, reduce the need for finishing work, and can grow despite a shortage of skilled workers.



05

#### **Fast**

set-up and start

04

#### **Simple**

operation and programming

03

#### **Flexible**

working and positioning

01

## Top quality

welding with the laser

You can create slim high-strength seams quickly with the deep welding process. Heat conduction welding enables you to produce visible seams of the highest visual quality.

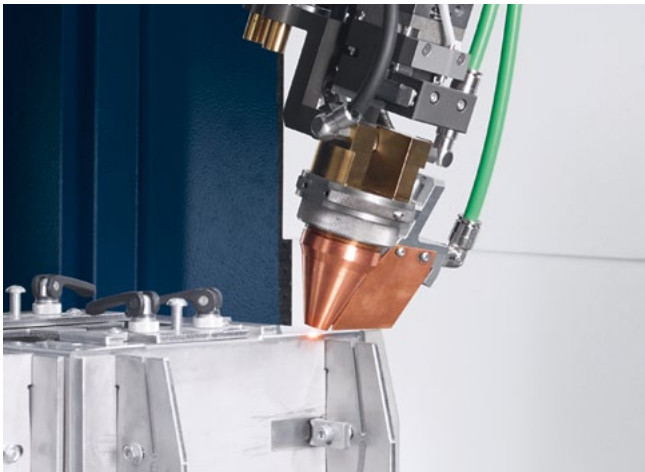

02

## Productive

welding in two-station operation

In two-station operation, you set up parallel to production and thus weld larger series highly productive. You can select whether you use the same program or different programs on stations one and two.

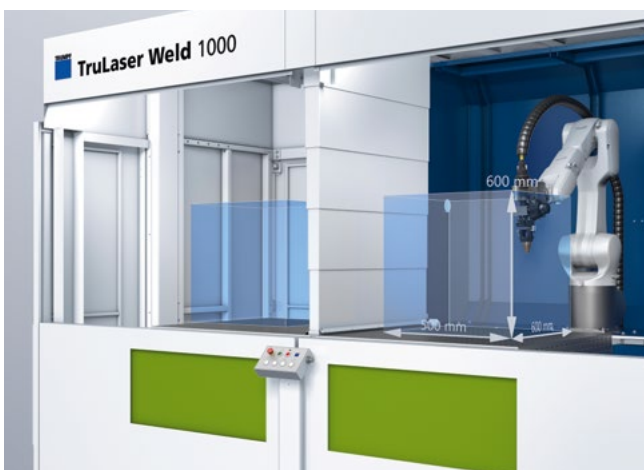

03

## Flexible

working and positioning

You can utilize the welding cell in one- or two-station operation, depending on the component and lot size. Components can be placed flexibly and precisely on the work table. With the optional rotary axes, components can be precisely aligned.



04

## Simple

operation and programming

Easy programming is the wild card of the welding cell – you can create your program without any robot code. You can easily find the right waypoints using a high-resolution camera image. Operators without expert knowledge of robots use the optional operating units for simple programming. They use the button on the welding torch to enter the welding start and end point directly. They can move the robot arm manually from waypoint to waypoint using a 6D mouse.



05

**Fast**

set-up and start

The machine is installed within one day. Instead of training courses, e-learning courses are sufficient to program and operate the machine. Welding parameters? Come with the machine! This allows you to weld your first part in the shortest possible time.

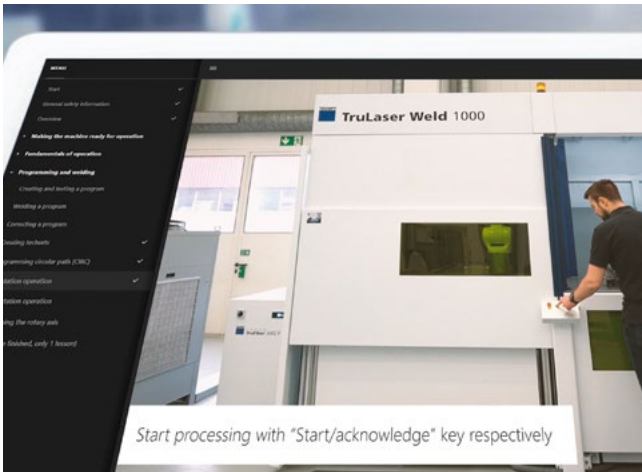

- 01 Industrial robot on a linear axis
- 02 Welding optics
- 03 Camera for teaching
- 04 Optional operating unit for simple programming
- 05 Inert gas nozzle
- 06 HMI with simple programming without robot code
- 07 Work table 2000 × 1000 × 100 mm (hole pattern D16 in 50 × 50 mm increments)
- 08 Center separation for two-station operation
- 09 Safety cabin with lighting, center separation and suction system



# TruLaser Weld 5000



01

## Enjoy flexible laser welding

with different welding processes in one system

02

## Secure joining

with collision protection and functions such as TeachLine

03

## Work in a way that is more user-friendly

thanks to the intuitive user interface



### **Automated laser welding: Productive and flexible**

Robots, lasers, processing optics, enclosed safety cabin, and positioners – TruLaser Weld 5000 is a turnkey system for automatic laser welding. You can adapt the versatile system exactly to your needs.

07

### **Individual loading**

with variable installation variants

06

### **Straightforward clamping**

with standard or zero-point clamping system

05

### **XXL welding**

with robot on a linear axis

04

### **Improve accessibility**

with rotary module for protective gas guide

01

### Enjoy flexible laser welding

with different welding processes in one system

Heat conduction welding, deep penetration welding, BrightLine Scan, or FusionLine: Different welding processes are available on your TruLaser Weld 5000 laser welding cell. Exploit this potential to significantly reduce your part costs. Using the welding program, you simply set the process, the amount of shielding gas, and strength of the compressed-air crossjet at the optics.



You simply set the right process using the welding program.

02

### Secure joining

with collision protection and functions such as TeachLine

Collision protection for the optics and the sturdy robot ensure reliable processes. Four LED lamps on the protective glass monitoring unit indicate the degree of contamination and thus save visual inspections. The TeachLine sensor system also reduces the effort for reteaching. It detects when the real position deviates from the required position and corrects the program automatically. With the aid of the second line laser, you can measure regardless of direction. A special added benefit: thanks to the optimized welding process visualization, you can already check the seam during welding.

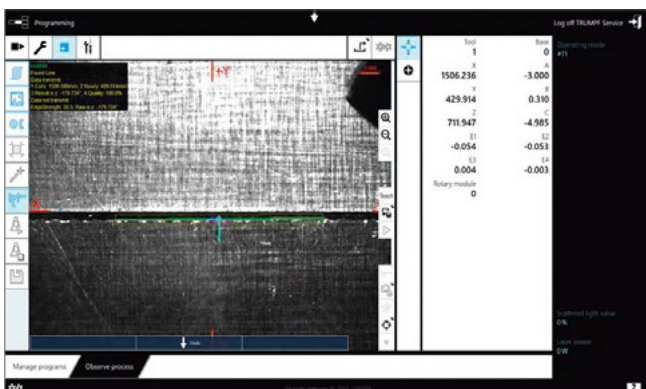

Reduce reteaching: Save time with TeachLine.

03

### Work in a way that is more user-friendly

thanks to the intuitive user interface

Details such as the additional production status monitor or the well-thought-out and clear HMI on the machine ensure that work is easier. They can be operated simply by touch and by drag and drop. The production plan with progress display allows you to keep an eye on your order processing and easily change the program sequence. You can program your components using TruTops Weld in the office or directly at the robot. Large windows give you a good view into the work area – the automatically opening door allows quick access.



With the additional status monitor, you can also keep an eye on the process remotely.

04

### Improve accessibility

with a rotary module for shield gas guidance

The shielding gas nozzle can be moved a full 360° around the processing optics. This reduces the need for the robot to realign itself, reducing the time and effort required for clamping and programming. The rotary module makes your parts more accessible, boosting welding speed considerably.

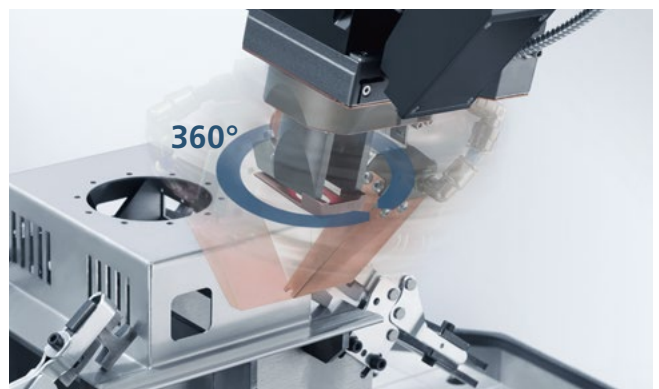

The rotary module for shield gas guidance allows users to rotate the nozzle 360° around the processing optics.

05

## XXL welding

with robot on a linear axis

A larger version of the TruLaser Weld 5000 with a 4 m wide door, a turnover positioner and an additional linear axis enables the welding of particularly large components. Thanks to its rotary axis, the turnover positioner aligns components so that the welding robot can easily reach them. The robot travels on a linear axis, giving it a greater reach. The spacious interior also offers room to use an additional rotate and tilt positioner or a dual station table. Cart systems can facilitate material flow when needed.



06

## Straightforward clamping

with a standard or zero-point clamping system

Use standard clamping systems to flexibly position fixtures or a zero-point clamping system to change fixtures quickly and precisely.

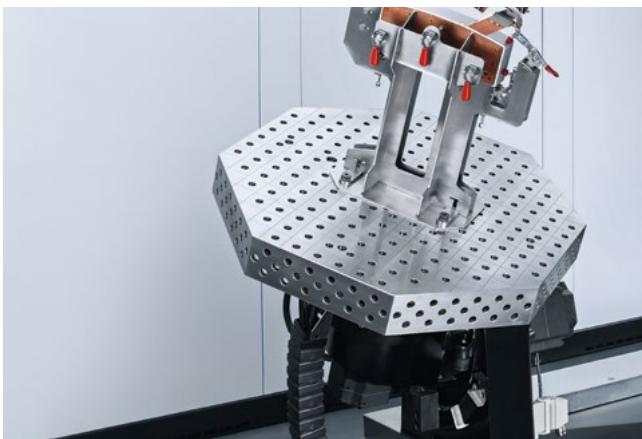

Standard clamping system



Zero-point clamping system

07

## Individual loading

with variable installation variants

Select the workpiece positioners that best fit your needs. You can choose between the rotate and tilt positioner, dual station table, rotary table and the turnover positioner for particularly large components. In the case of rotationally symmetrical parts, for example on the dual station table, the modular rotary axis is also suitable.

### Workpiece positioner for selection



The rotate and tilt positioner makes even difficult-to-access components weldable in just one clamping.



During the welding process, you set up the dual station table outside the cell, which increases the efficiency of your system.



The compact rotary table with clamping plate is ideal for quick, fully automated rotation of the positioner.



The compact rotary table with vertical rotary axis offers even more flexibility.



The rotary table with turning axes automatically rotates even larger components into the welding cell.

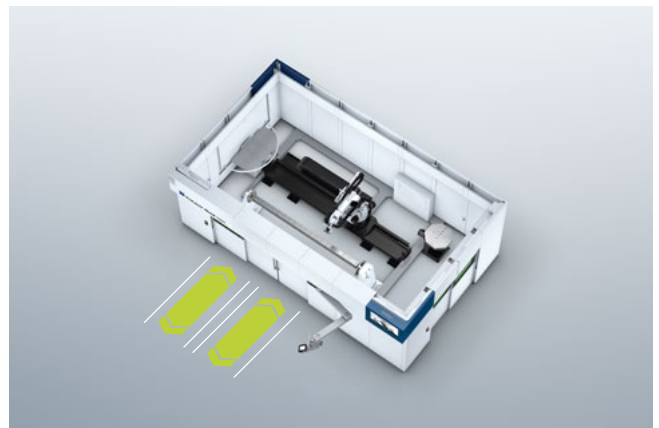

XXL components are handled by the turnover positioner. The robot travels on a linear axis and thus has a greater range. If necessary, a cart system can facilitate material flow.

## The key element of your system: The welding optics

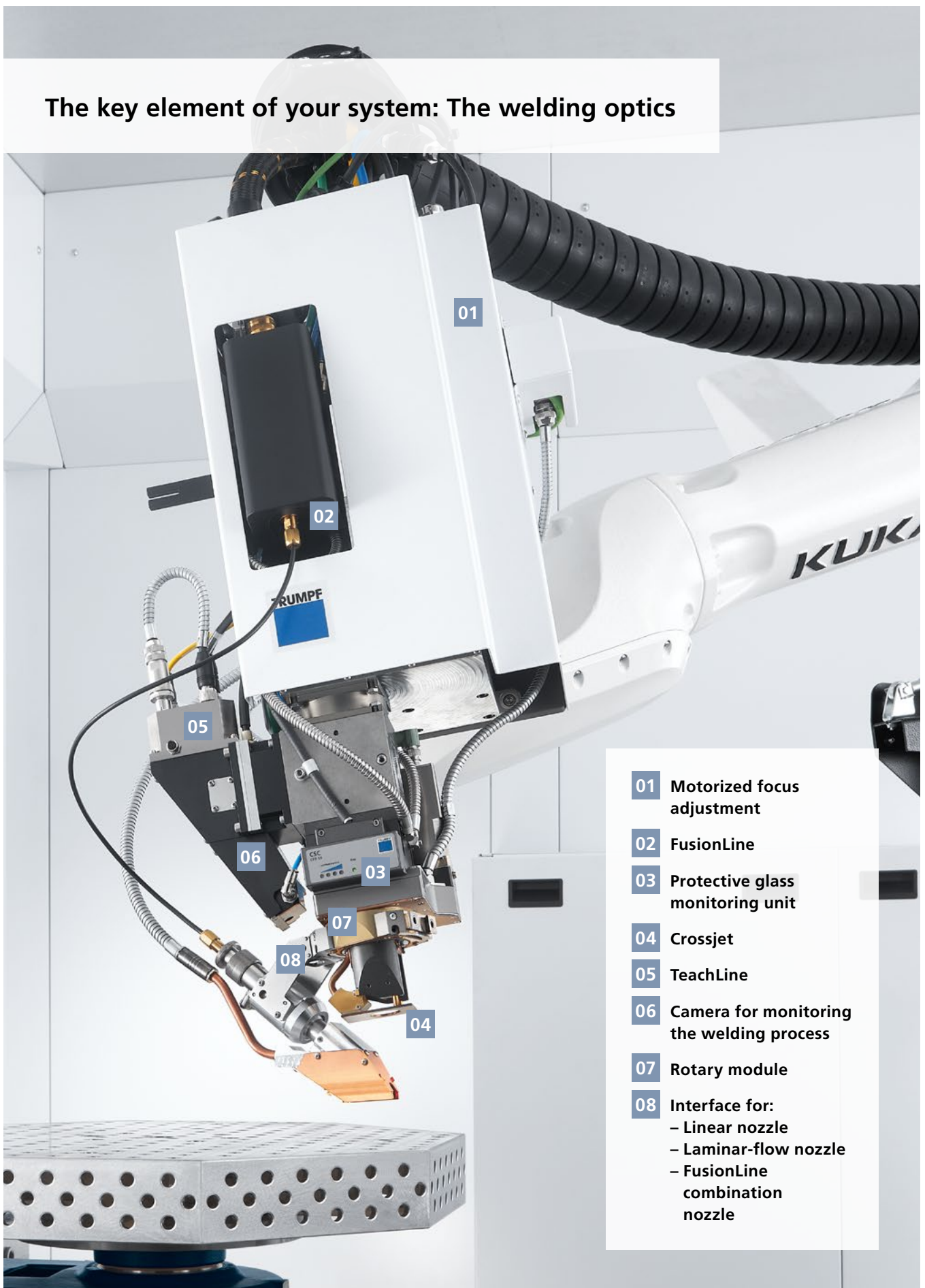

# Technical data

Max. welding depths for deep penetration welding <sup>[1]</sup>				
Power	W	3000	4000	6000
Stainless steel	mm	5	7	10
Mild steel	mm	5	7	10
Aluminum	mm	3	4	6

<sup>[1]</sup> Guide values: Exact maximum values depend, for example, on the material properties.  
Content subject to change without notice. Only specifications in our offer and order confirmation are binding.

Max. sheet thicknesses for heat conduction welding <sup>[1]</sup>				
Power		3000 W	4000 W	BrightLine Scan <sup>[2]</sup>
Stainless steel	mm	2.5	3	6
Mild steel	mm	2.5	3	6
Aluminum	mm	2.0	2.5	4

<sup>[1]</sup> Guideline values at 70% overlap: Precise maximum values depend, for example, on the material properties.  
<sup>[2]</sup> Standard tech sets available up to a sheet thickness of 4 mm.  
Content subject to change without notice. Only specifications in our offer and order confirmation are binding.

**Greater laser power not only increases the maximum possible sheet thickness, but also the welding speed.** Here you can see sample parameters. For thinner sheets, you can weld even faster, e.g. 1 mm stainless steel at 18 m/min. You can also optimize the parameters even further on a component-specific basis.

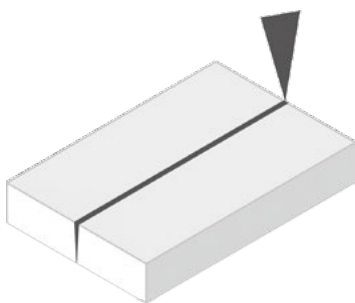

		3000 W	6000 W
<b>2 mm aluminum</b>	Standard	7 m/min.	10.2 m/min.
	BrightLine Scan	3.5 m/min.	5.3 m/min.
<b>1.5 mm stainless steel</b>	Standard	8 m/min.	13 m/min.
	BrightLine Scan	3.4 m/min.	6 m/min.
<b>3 mm mild steel</b>	Standard	3 m/min.	7 m/min.
	BrightLine Scan	1.8 m/min.	4.3 m/min.

## TruLaser Weld 1000

Technical data		
<b>Handling system</b>		
Type	Industrial robot	
Number of axes	6	
Range	mm	1101
Repeatability	mm	± 0.02
<b>Welding cabin</b>		
Cabin dimensions (W × D × H)	mm	3605 × 2454 × 2818
Weight	kg	3850
<b>Work area</b>		
Work table carrying capacity	kg	1000
Typical max. component size (with open extendible partition wall)	mm	2000 × 600 × 600
Typical max. component size (with closed extendible partition wall)	mm	600 × 600 × 600
Typical max. component size (with closed extendible partition wall)	mm	500 × 600 × 600
<b>Laser</b>		
Available lasers	TruFiber 3002	

Content subject to change without notice. Only specifications in our offer and order confirmation are binding.

## TruLaser Weld 5000

Technical data		
<b>Handling system</b>		
Type	Industrial robot	
Number of axes	6	
Range	mm	2101
Repeatability	mm	± 0.05
<b>Welding cabin</b>		
Possible cabin dimensions (W × D, height 3200 mm)	mm	4800 × 3650   4800 × 4800   4800 × 5950   5950 × 4800   5950 × 5950 7100 × 4800   7100 × 5950   8250 × 4800   8250 × 5950 9400 × 4800   9400 × 5950
<b>Positioner</b>	<b>Max. load</b>	<b>Max. work area</b>
Rotate and tilt positioner <sup>[1]</sup>	400 kg	2000 × 1000 × 700 mm
Dual station table (per side)	250 kg	1600 × 800 × 1200 mm
Compact rotary table with 3D clamping plate (per side)	430 kg <sup>[2]</sup>	1800 × 1000 × 1000 mm
Compact rotary table with vertical rotary axes (per side)	435 kg <sup>[3]</sup>	∅ 1250 × 800 mm
Rotary table with horizontal turning axes (per side)	750 kg	2000 × 1000 × 1100 mm
Turnover positioner with robot on linear axis <sup>[1]</sup>	1000 kg	4000 × 1500 × 1000 mm
<b>Laser</b>		
Available lasers <sup>[4]</sup>	TruFiber 3001, 4001, 6001   TruDisk 4001, 6001, 8001	

<sup>[1]</sup> Typical maximum values, other width, depth, height ratios possible. <sup>[2]</sup> 3D clamping plate has already been taken into account.

<sup>[3]</sup> The rotary axis and clamping plate have already been taken into account. <sup>[4]</sup> The required machine configuration influences the choice of laser.

Content subject to change without notice. Only specifications in our offer and order confirmation are binding.

# TruTops Weld: Program faster and produce at the same time

The navigation system in your car guides you reliably to your destination. Wouldn't it be great to also have a navigation system for laser welding? Look no further than the TruTops Weld programming system. You can program offline on the computer while production continues on your machine. Adapt the program at the machine simply using TeachLine or by reteaching to the actual position of the component.

## The benefits for you: From the CAD model to the welding program in four steps

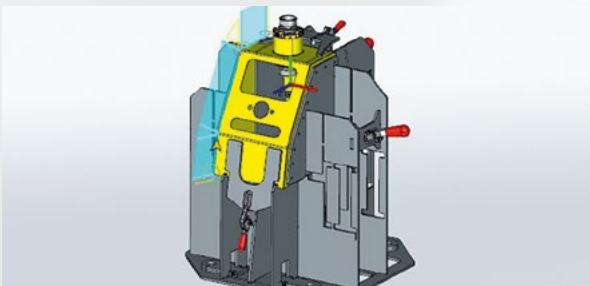

### 1. What do you want to weld?

Load your component into TruTops Weld and mark the seams to be welded.

The software is easy to use and packed full of TRUMPF expertise, such as welding parameters and processing angles. You select only the necessary values, and the program is created automatically – offline on the computer, reducing your nonproductive time.

**> You program faster and reduce nonproductive time**

TechSet	Material	SheetThickness	Technology	PowerMax	RobotFeed
T000	S235	3	Other	1500	0
T101	1,4301	0.5	Heat conduction welding	1000	0.02
T103	S235	1	Heat conduction welding	1800	0.02
T104	S235	1.5	Heat conduction welding	2500	0.02
T105	S235	2	Heat conduction welding	3000	0.015
T120	AlMg3	0	Other	1200	0
T122	S235	1	Deep penetration welding	1000	0.0333

### 2. How do you want to weld?

Select the welding parameters that fit your material and desired result for heat conduction welding, deep penetration welding, or FusionLine.

Programming is performed on the computer in the office, and operation carried out at the machine – one person can be responsible for this, or a team of operators and programmers.

**> Deploy staff in a targeted way**



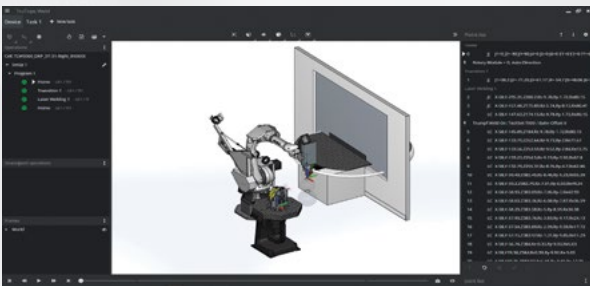

### 3. Where do you want to weld?

Position the component virtually on the desired component positioner. Due to TruTops Weld, you can quickly detect possible collisions and adapt the program. The software makes suggestions and makes it easier to check the accessibility of complex components.

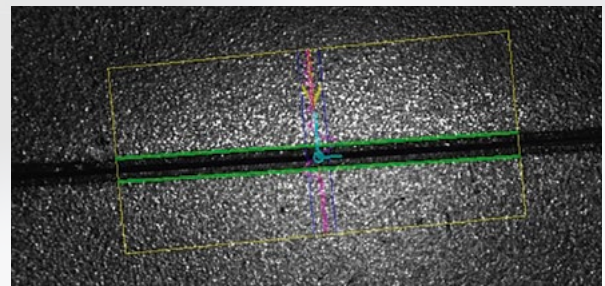

### 4. The fast track to the desired result

Load the program created offline onto your precisely calibrated TruLaser Weld 5000. TeachLine detects the actual position of your component and automatically adapts your program. This reduces your effort for retooling significantly. Alternatively, you can retool the program conventionally.

➤ You simplify complex tasks

➤ You can profitably produce even small quantities



# Increase productivity with know-how

Benefit from years of experience! Seminars, workshops or application support get you ready for laser welding. In the WeldGuide, you will also find exclusive tips on laser welding and many practical examples, completely free of charge. And maybe you will even discover new opportunities for future orders!

**Support can be booked in the form of seminars, workshops and application consulting**

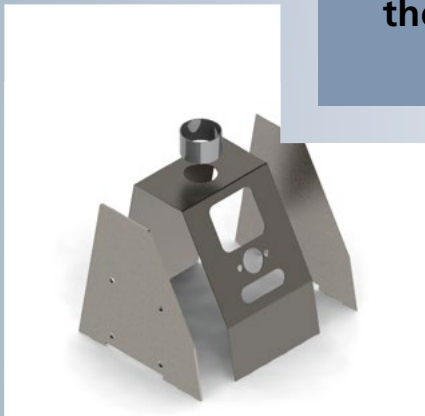

## Seminar on laser welding design

### Ready for part design

Economically design laser-welded parts: learn how to exploit the full potential compared to traditional welding processes.

- Establish design rules
- Design your components productively
- From sketch to solution



## Workshop or seminar for fixture design

### Fixtures made easy

Learn how to design cost-effective fixtures from sheet metal using practical examples.

- Learn drafting design and construction rules
- Easily optimize fixtures
- Clamp parts well and economically



## Application consulting

### Simply better welding

An application engineer from TRUMPF will support you on location.

- Define optimal welding parameters for your component
- Create a laser welding program
- Run in the parts on the machine

## At a glance: These and other topics can be found in the WeldGuide

### Basics

You will find all of the basic terms and technologies for implementing your laser welding application in our information database. You will be given tips on laser-compatible component and fixture design, as well as in-depth user expertise for laser welding applications and TruTops Weld.

### Configurator

You can configure your machine with the corresponding welding optics to check the accessibility of your components and fixtures in your own CAD tool. All standard machines and optics models are available for download.

### Example parts

The WeldGuide offers practical example components and different sample fixtures on which the basics were applied. A detailed CAD model of each component is provided which, as a TRUMPF customer, you can download.

### Calculator

Create calculations to see a direct cost comparison of laser and arc welding.



**Free of charge:** Just log in to the MyTRUMPF portal for full access



**Valuable:** Technological expertise, techniques and methods collected in one database



**Practical:** Use practical example parts and fixtures as templates



**Open:** Download the components, fixtures and machine models as CAD models.

Sounds interesting? This way to the WeldGuide:  
[weldguide.trumpf.com](http://weldguide.trumpf.com)



# Easy automation of manual welding

Do you weld conventional sheet metal parts manually using an electric arc? Often in very small quantities? Then you may be familiar with this scenario: Welding specialists are difficult to find; programming or laser-compatible design is usually not worthwhile in these cases. The specialist knowledge required for setting up a welding robot is also often lacking. The TruArc Weld 1000 provides a remedy. The arc welding cell is profitable even for very small lot sizes, is easy to program, and can be operated by non-expert workers. Your welding experts then have more time for the more complex tasks.

## TruArc Weld 1000

Get started with automated welding



**Fully inclusive**

The welding cell is a fully equipped machine tool, tested by the Technical Supervisory Association (TÜV) and CE-compliant. This also includes the suction system, housing with anti-glare protection, safety technology in TRUMPF quality.

**Fully intuitive**

You can start, program and operate the welding cell without training – e-learning is sufficient.

**Fully flexible**

Use one- or two-station operation depending on requirements. You can then work on one larger component or smaller components in large series parallel to production.

➤ **Radically easy programming**

➤ **Profitable automated welding from the first part**



More information on the  
TruArc Weld 1000 is available here:  
[www.trumpf.info/2stm8z](http://www.trumpf.info/2stm8z)



# Your Smart Factory



# 80%

Indirect processes make up 80% of your production time – this is where the greatest potential for saving lies.



Discover what potential networked production offers for you with two example scenarios: [www.trumpf.com/s/smart-factory](http://www.trumpf.com/s/smart-factory)





Gain more freedom with networking: You see more, know more, and get the best out of your production system. With TruConnect, the synonym for Industry 4.0 at TRUMPF, you can design your Smart Factory step by step. The pragmatic solutions from TRUMPF support you on your path towards networked production, helping you to make your entire process more transparent, more flexible, and above all more cost-effective.

---

### For companies big and small: From the simple product solution right through to fully networked production

---

- **Start simply** with machines that are equipped for networking as standard.
- **Customize step by step** with automated machines or autonomous processing cells embedded in a production solution.
- **Enjoy full networking** with a continuous production solution, from order to delivery.

---

### Production flow with Oseon

---

Integrate your TruLaser Weld machines into Oseon – a comprehensive solution for production and material flow control. You have an overview and control of all the relevant processes in your sheet metal processing in just one system: with Oseon, you can optimize your workflows and unleash the potential of your production.

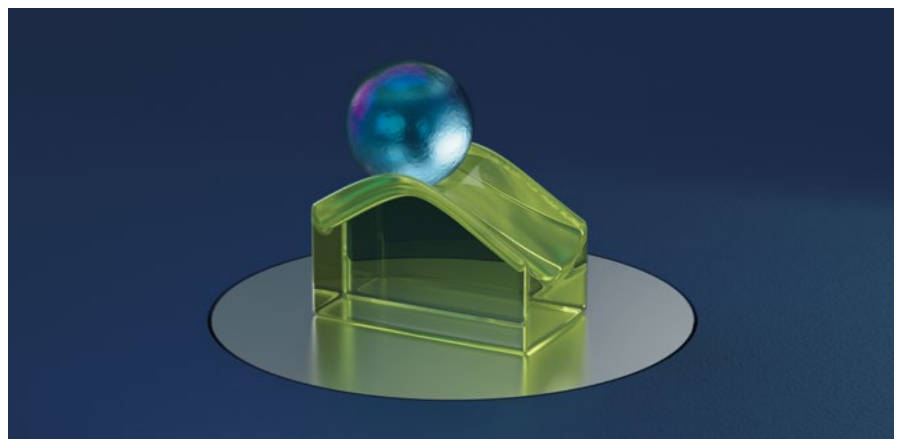

You can find **further information** on networked production here:  
[www.trumpf.com/smart-factory](http://www.trumpf.com/smart-factory)

# TruServices. Your Partner in Performance

For a successful future, choose services that will help you progress in the long term: Whether you want to create the best conditions for successful manufacturing, make the most of your TRUMPF laser systems, or have the flexibility to adapt them to changing requirements – together we will find opportunities to maximize your value creation long-term. We will provide you with all-round support as a reliable partner with solutions and service packages for your needs – enabling you to manufacture economically and at a constantly high level.

## EMPOWER

**If you want to create the best conditions for successful production, we will support you in this.**



### **Training – reach your full potential with professional development**

If you are well trained, you can fully utilize the potential of your lasers, laser systems, machines and software, and secure key competitive advantages. In the seminar on fixture design, for example, you will learn how to manufacture fixtures economically from sheet metal.

## SUPPORT

**If flexibility and availability of equipment in day-to-day operations are essential to you, we can help.**

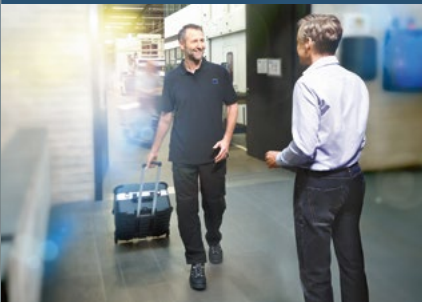

### **Service app – the app for your service messages**

Whether it's a technical problem, software, a spare part or a question concerning maintenance: with the Service app and your free MyTRUMPF account, you can send your service messages quickly and easily to our Technical Service team at any time.

## IMPROVE

**If you want to gradually focus your production on maximum value creation, we can help you achieve your goal.**









### **Service agreements – get just the service you need**

Where system maintenance and servicing are concerned, you will benefit from expert support of the highest quality. Ensure constant maximum machine availability, consistently high production quality, and low operating costs with service agreements from TRUMPF.





 Financing	 Training	 Technical Service	 Genuine parts	 Tools	 Service agreements
 Software	 Process optimization	 Monitoring & analysis	 Product enhancements	 Pre-owned machines	



You can learn more about our complete and comprehensive package of useful services here: [www.trumpf.com/s/services](http://www.trumpf.com/s/services)



# Working in perfect harmony for your success

From the machine to the laser and the optical system, to the technology data: Intelligent machine functions are based on the interaction of different components. This is why we focus on integrated solutions down to the last detail – the best basis for your success.



**You have an optimally available production system.**

## TruServices

We are always there for you with our comprehensive range of services and a global service network.

## Software

With software solutions from TRUMPF, you can optimize your manufacturing process. The TruTops Weld programming system is optimally matched to your machine.

## Automation

There are various workpiece positioners for your TruLaser Weld machine, for example a rotary table for loading and unloading parallel to production.

## Process expertise

Each machine contains current technology data for laser welding that has been tested by TRUMPF –so you can get started easily.

## Optical system

We develop lasers, laser light cables and welding optics for each batch adapted to the respective requirements. Your advantage: You can use the laser tool's power to the fullest.

## Machine

All TruLaser Weld machines are developed and produced by TRUMPF – they are a robust solution for your day-to-day industrial applications.

# Passion is what drives us

Whether it's production and manufacturing technology, laser technology, or material processing – we develop highly innovative products and services for you which are tailored to your industry and which are absolutely proven and reliable. We put everything we've got into giving you a compelling, competitive edge: expertise, experience, and above all passion.



Check out our  
YouTube channel:  
[www.youtube.com/  
@TRUMPFtube](http://www.youtube.com/@TRUMPFtube)



## Machines & systems

Laser cutting, punching, bending, laser welding: With custom-fit machine tools, laser systems and automation from TRUMPF, you can master flexible sheet metal and tube processing. Not forgetting our solutions for additive manufacturing.



## Lasers

Whether you are cutting, welding, marking or processing surfaces, lasers from TRUMPF are the universal tools for industrial applications – in the macro, micro and nano ranges. In addition, you will get software solutions and benefit from application knowledge and consulting.

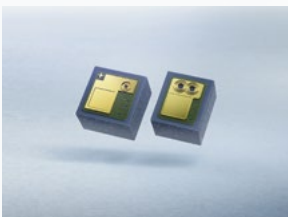

## VCSEL solutions & photodiodes

Laser and photodiodes from TRUMPF Photonic Components come into their own in numerous applications: in both the industrial and consumer markets and even in optical data communication. In the TruHeat VCSEL systems, millions of VCSELs (Vertical Cavity Surface Emitting Laser) generate infrared heat, which is used for laser heat treatment.



## Power electronics

Nothing's hi-tech without a process power supply: With generators for plasma technology, industrial heating, battery inverter systems or microwave amplifiers, you get power at the frequency and performance you need.



## Solutions for your future

Take advantage of digital networking opportunities: we partner with you on the path to networked production, delivering pragmatic, economical solutions that make your processes both more transparent and flexible.

TRUMPF is certified to ISO 9001  
(Find out more: [www.trumpf.com/s/quality](http://www.trumpf.com/s/quality))

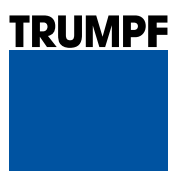

TRUMPF Werkzeugmaschinen SE + Co. KG  
[www.trumpf.com](http://www.trumpf.com)